

1. Applications

- n High efficiency synchronous rectification in SMPS
- n High speed power switching

2. Features

- n $R_{DS(on)}=5.0m\Omega$ @ $V_{GS}= 10 V$
- n Super high dense cell design
- n Ultra low On-Resistance
- n 100% avalanche tested
- n Lead Free and Green devices available (RoHS Compliant)

3. Pin configuration

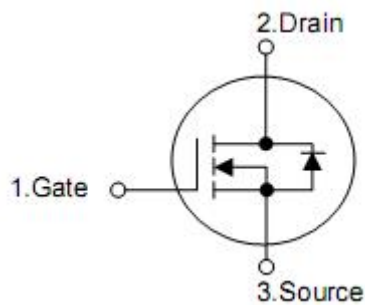
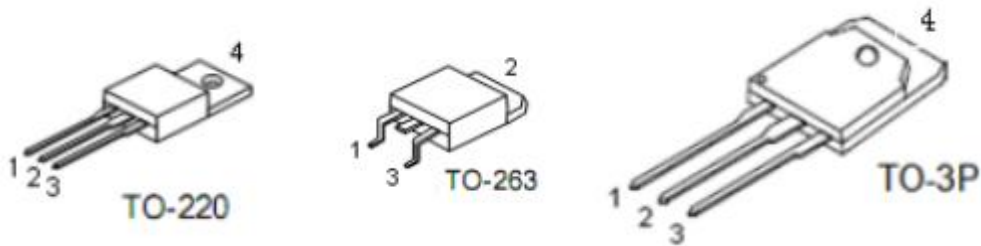

Pin	Function
1	Gate
2	Drain
3	Source
4	Drain

4. Ordering Information

Part Number	Package	Brand
KNB2910A	TO-263	KIA
KNP2910A	TO-220	KIA
KNH2910A	TO-3P	KIA

5. Absolute maximum ratings

($T_C=25\text{ }^\circ\text{C}$, unless otherwise specified)

Parameter	Symbol	Ratings		Units	
		TO-220/263	TO-3P		
Drain-source voltage	V_{DSS}	100		V	
Gate-source voltage	V_{GSS}	± 25		V	
Continuous drain current $T_C=25\text{ }^\circ\text{C}^2$	I_D	130		A	
Continuous drain current $T_C=100\text{ }^\circ\text{C}^2$		99		A	
300us pulsed drain current tested $T_C=25\text{ }^\circ\text{C}^1$	I_{DP}	560		A	
Avalanche energy single pulse ³	E_{AS}	552		mJ	
Power dissipation	P_D	$T_C=25\text{ }^\circ\text{C}$	300	375	W
		$T_C=100\text{ }^\circ\text{C}$	150	187.5	W
Maximum junction temperature	T_J	175		$^\circ\text{C}$	
Storage temperature range	T_{STG}	-55~+175		$^\circ\text{C}$	
Diode continuous forward current $T_C=25\text{ }^\circ\text{C}$	I_S	140		A	

6. Thermal characteristics

Parameter	Symbol	Rating	Unit
Thermal resistance,Junction-to-case	θ_{JC}	0.5	$^\circ\text{C/W}$
Thermal resistance,Junction-to-ambient	θ_{JA}	62.5	$^\circ\text{C/W}$

7. Electrical characteristics

(T_C=25°C, unless otherwise notes)

Parameter	Symbol	Conditions	Min	Typ	Max	Unit
Off Characteristics						
Drain-source breakdown voltage	BV _{DSS}	V _{GS} =0V, I _D =250μA	100	-	-	V
Drain-to-source leakage current	I _{DSS}	V _{DS} =100V, V _{GS} =0V	-	-	1	μA
		T _J =125 °C	-	-	30	μA
Gate-to-source leakage current	I _{GSS}	V _{GS} =25V, V _{DS} =0V	-	-	100	nA
		V _{GS} =-25V, V _{DS} =0V	-	-	-100	nA
On characteristics						
Gate threshold voltage	V _{GS(th)}	V _{DS} =V _{GS} , I _D =250μA	2.0	-	4.0	V
Static drain-source on-resistance ⁴	R _{DS(on)}	V _{GS} =10V, I _D =40A	-	5.0	7.0	mΩ
Gate charge characteristics⁵						
Total gate charge	Q _g	V _{DS} =80V, I _D =70A, V _{GS} =10V	-	130	-	nC
Gate-source charge	Q _{gs}		-	32	-	
Gate-drain (Miller)charge	Q _{gd}		-	55	-	
Dynamic characteristics⁵						
Gate series resistance	R _G	V _{DS} =0V, V _{GS} =0V, f=1.0MHz	-	1	-	Ω
Turn-on delay time	T _{d(ON)}	V _{DD} =50V, I _D =70A, V _{GEN} =10V, R _G =5Ω	-	24	-	nS
Rise time	t _{rise}		-	91	-	
Turn-off delay time	T _{d(OFF)}		-	75	-	
Fall time	t _{fall}		-	65	-	
Input capacitance	C _{iss}	V _{DS} =50V, V _{GS} =0V, f=1.0MHz	-	6800	-	pF
Output capacitance	C _{oss}		-	630	-	
Reverse transfer capacitance	C _{rss}		-	350	-	
Source-drain body diode characteristics T_J=25°C, unless otherwise notes						
Diode forward voltage ⁴	V _{SD}	V _{GS} =0V, I _S =70A	-	-	1.2	V
Reverse recovery time	t _{rr}	I _{SD} =70A, di _F /dt=100A/μs,	-	43	-	ns
Reverse recovery charge	Q _{rr}		-	67	-	nC

Note: 1. Pulse width limited by safe operating area.

2. Calculated continuous current based on maximum allowable junction temperature. The package limitation current is 75A

3. Limited by T_{Jmax}, I_{AS}=47A, V_{DD}=48V, R_G=50Ω, Starting T_J=25°C.

4. Pulse test; Pulse width ≤300μs; duty cycle ≤2%.

5. Guaranteed by design, not subject to production testing.

6. KIA finished product specifications please customer before placing order, should obtain the latest version of the finished product specifications.

8. Typical characteristics

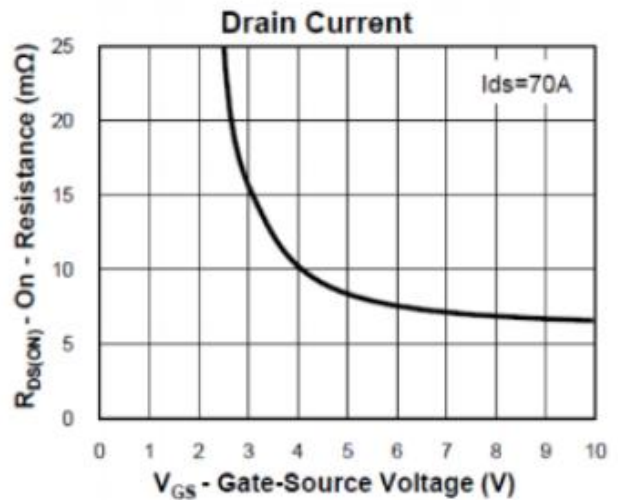
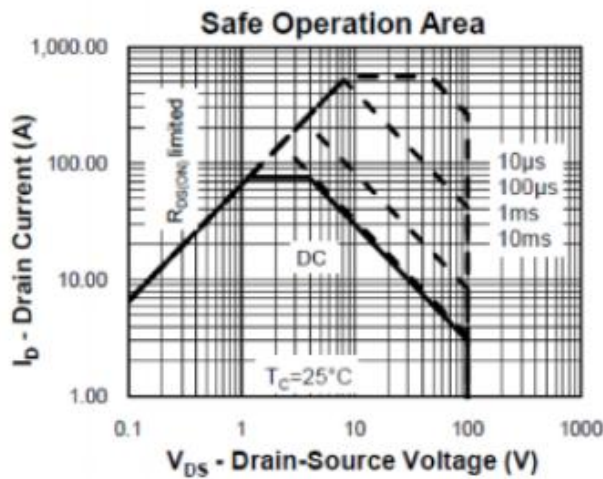
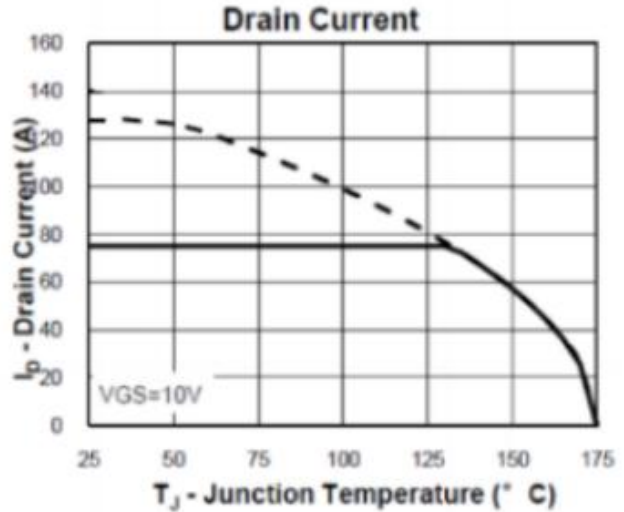
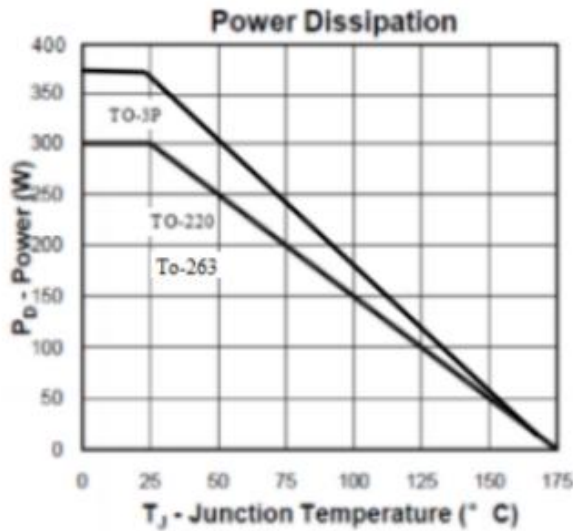

Thermal Transient Impedance

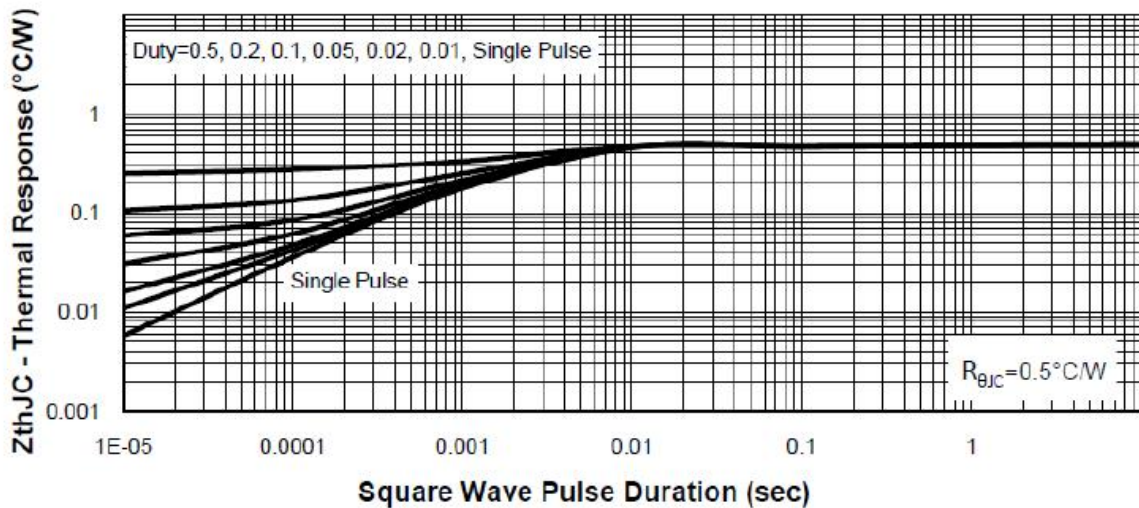

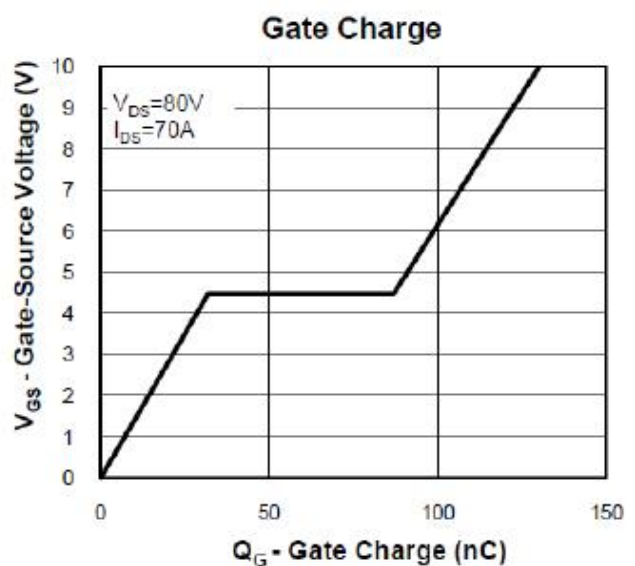
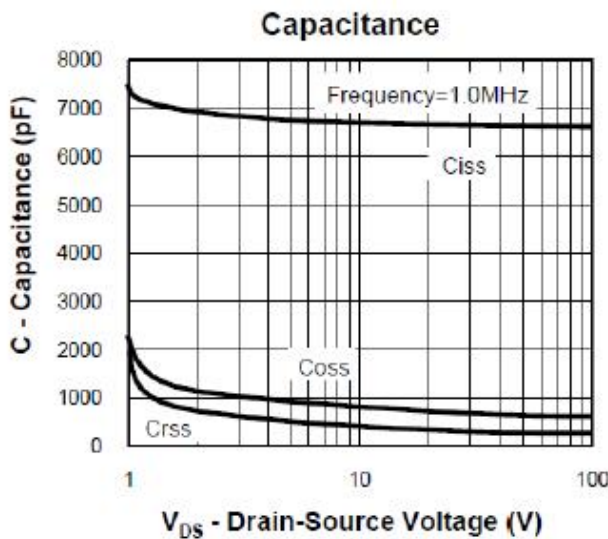
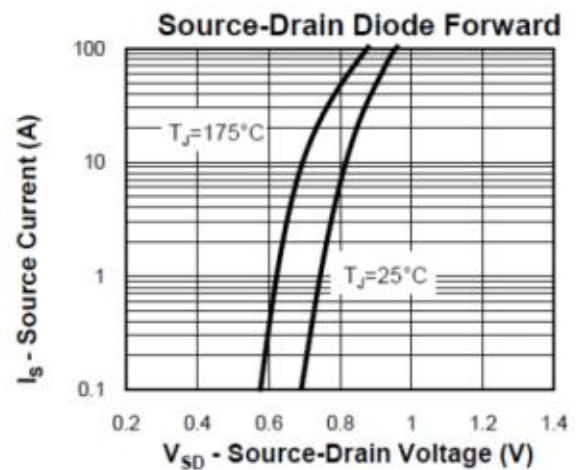
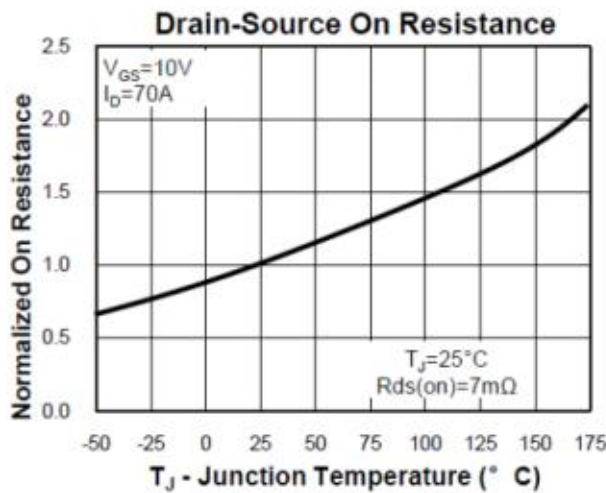
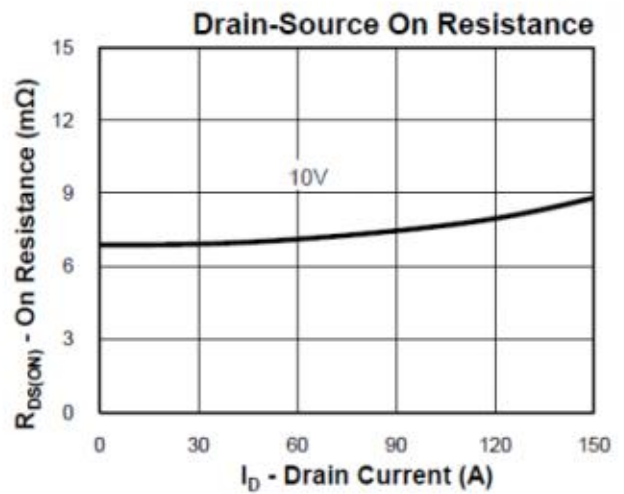
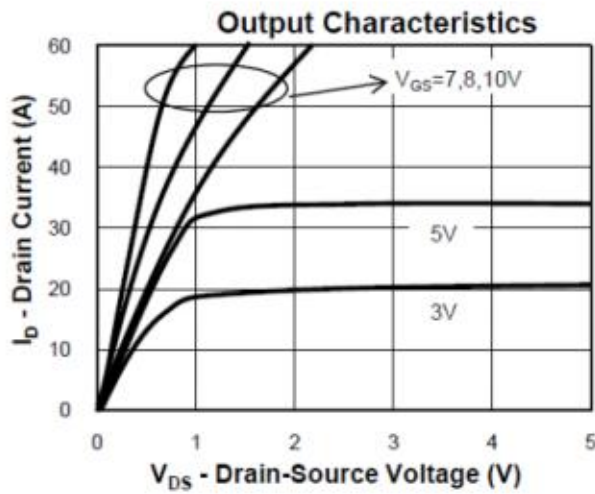

9. Test circuits and waveforms

Avalanche Test Circuit and Waveforms

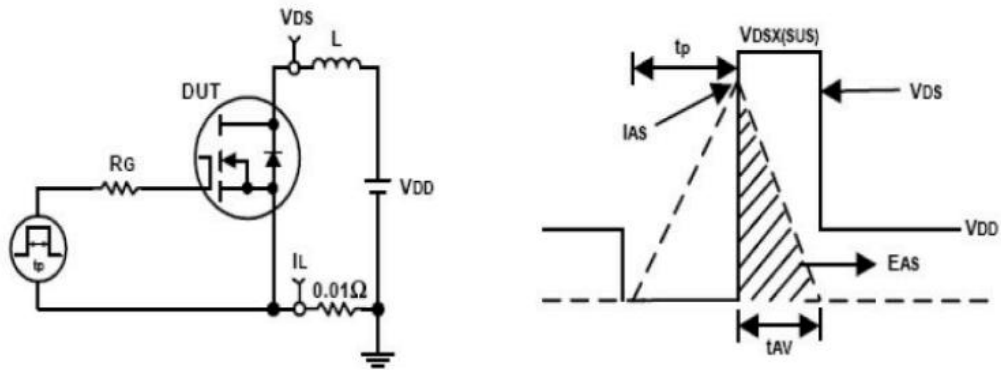

Switching Time Test Circuit and Waveforms

